

Data Sheet

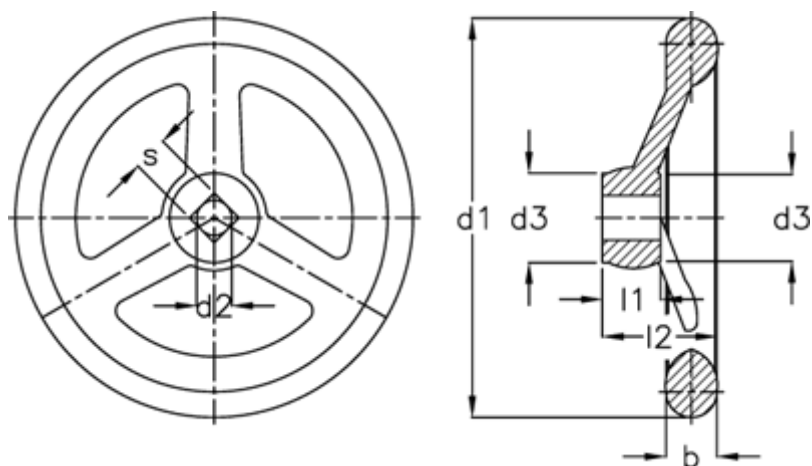

Article number: 20304335
Description: E+G Handwheel
DIN 950-AL-200-K22-A

Measures



b	= 22
d1	= 200
d2 H7	= 22
d3	= 38
l1	= 24
l2	= 45
Number of spokes	= 3